

# Dillon /Diana 40 (360x550)

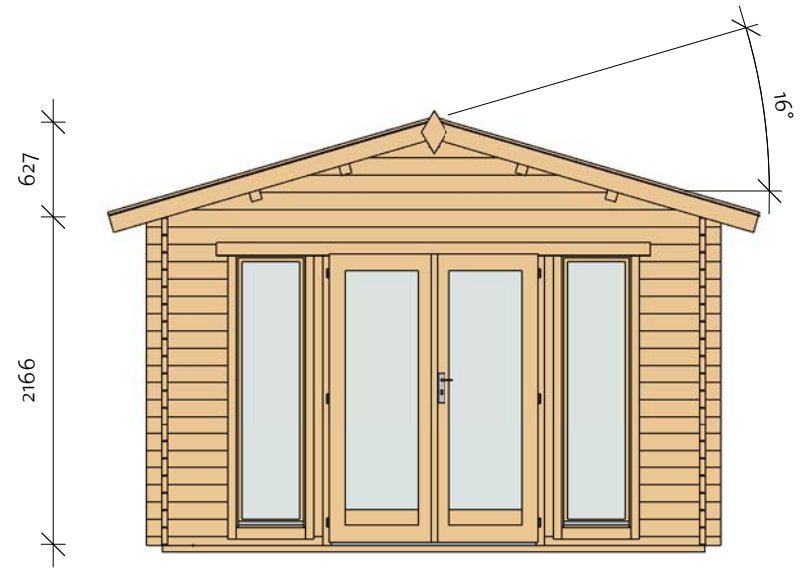

# Diana 40 (360x550)

Foundation

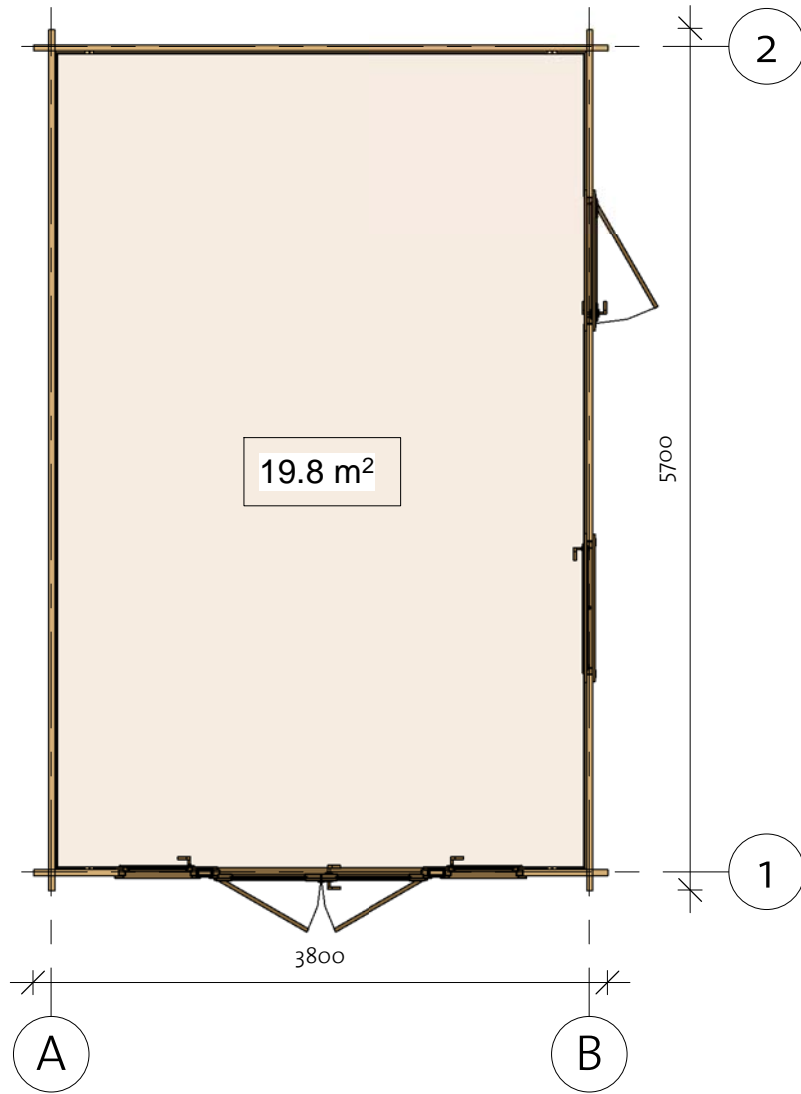
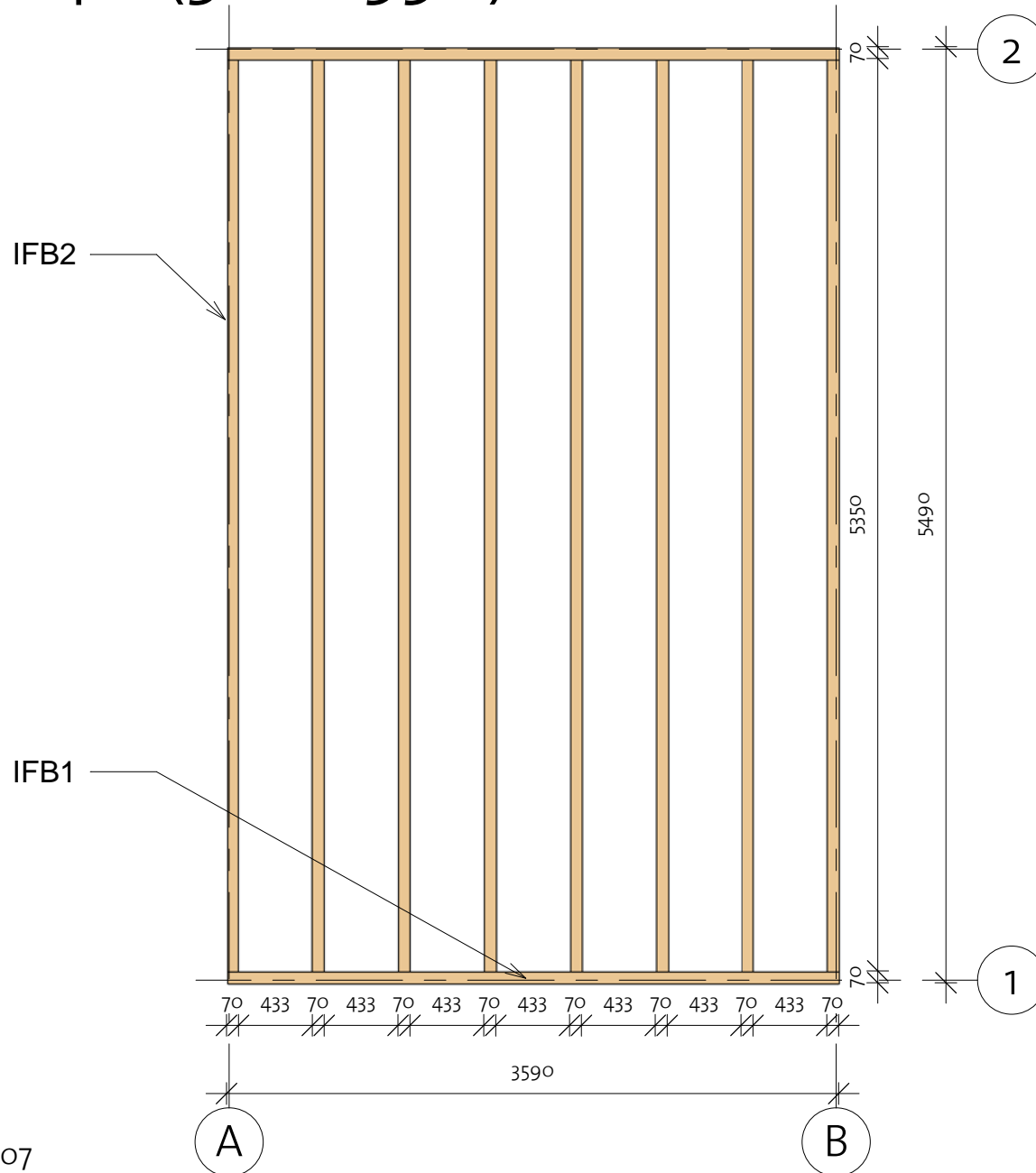

Impregnated foundation beams				
Mark	Type	Profile	Count	Length
IFB1	IFB 70x45		8	5350
IFB2	IFB 70x45		2	3590

# Diana 40 (360x550)

Floor Plan

① Baseboard

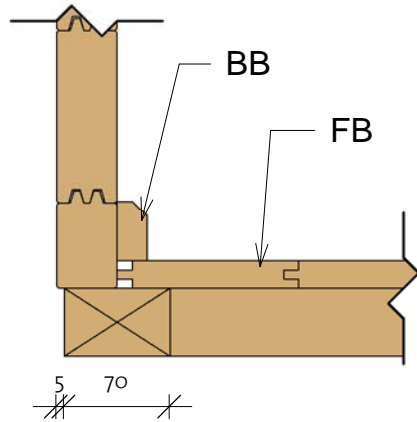

Floor Schedule

Mark	Type	Profile	Count	Length
------	------	---------	-------	--------

FB	FB 18x110		51	3517
----	-----------	---	----	------

BB1	BB 20x40		2	3600
BB2	BB 20x40		2	5500

91811052\_190507

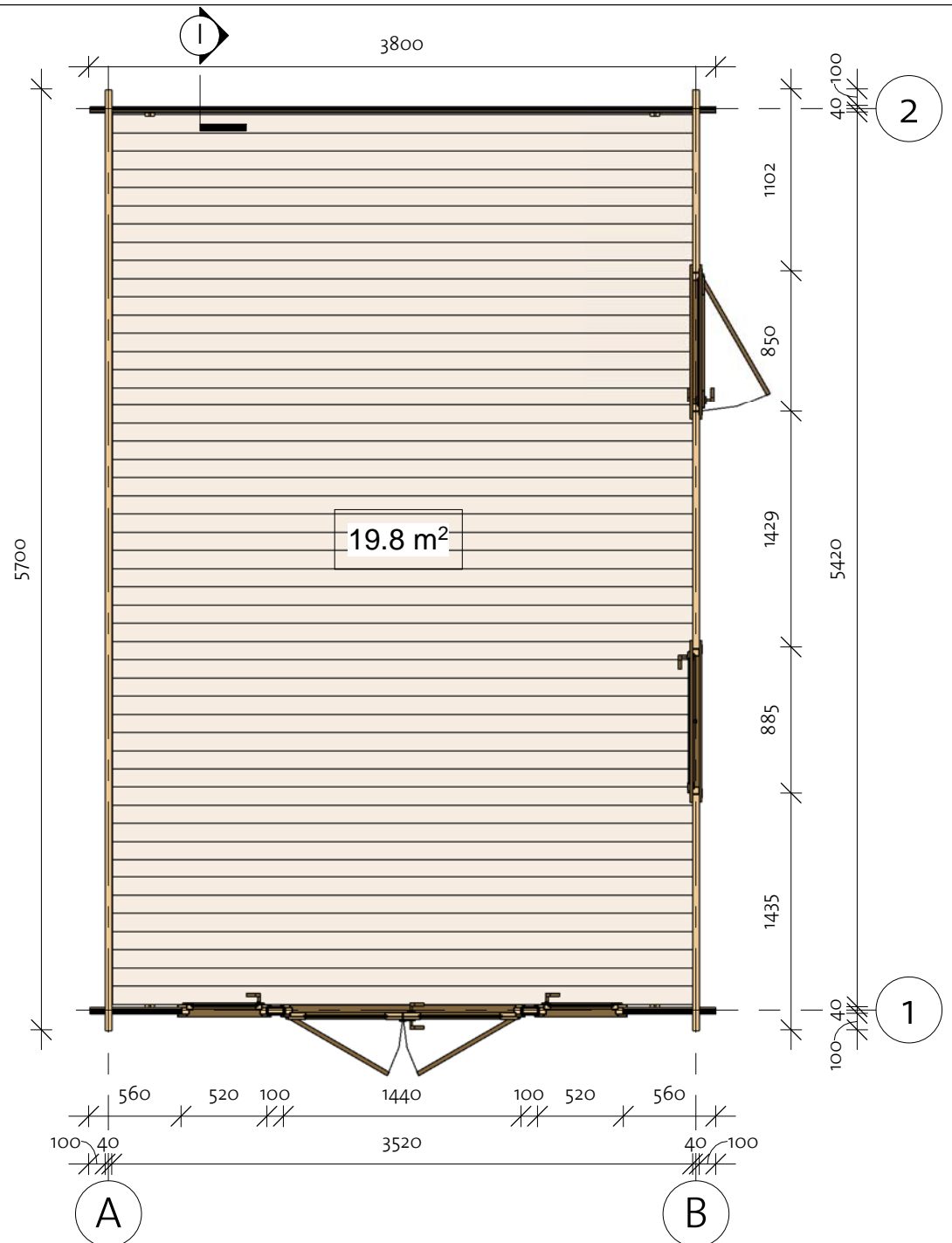

# Diana 40 (360x550)

Wall 1

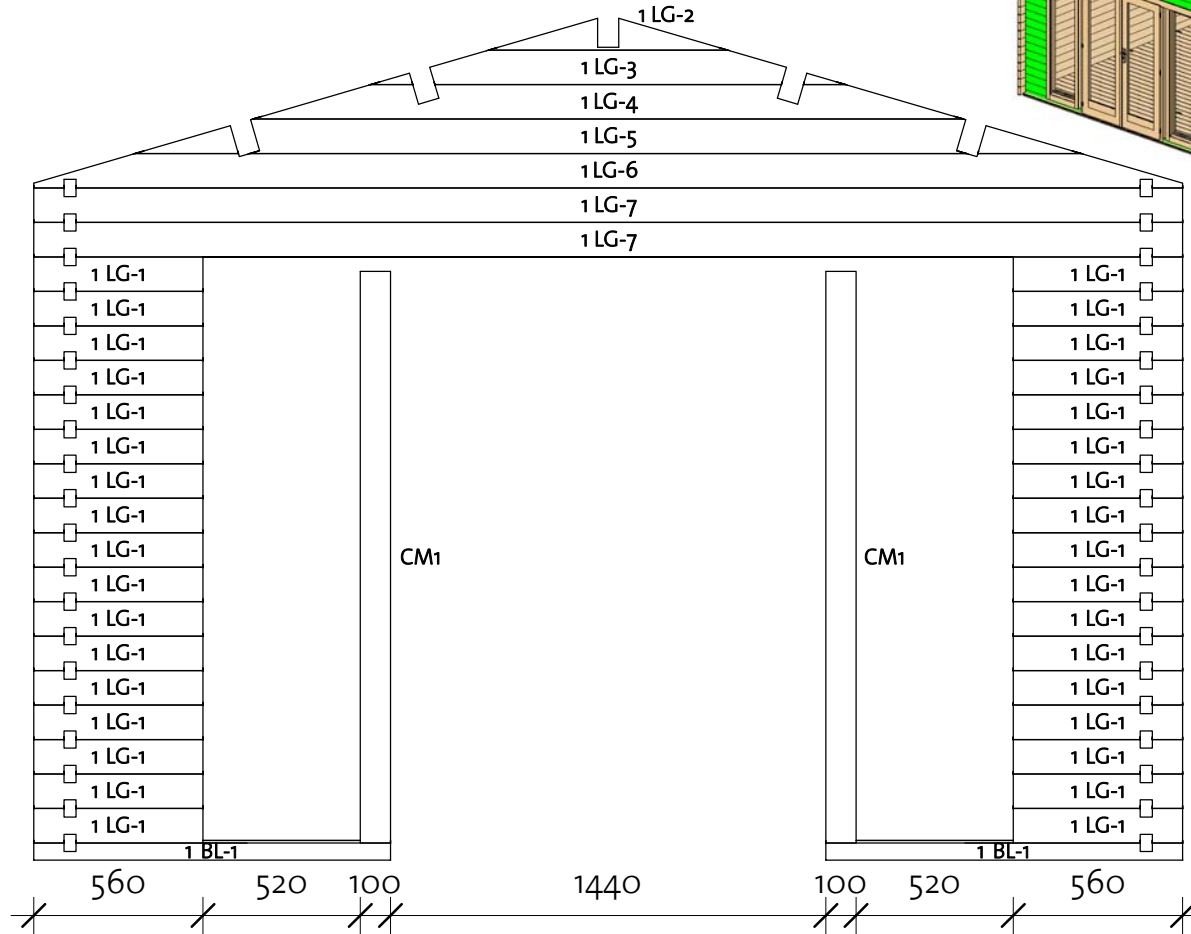
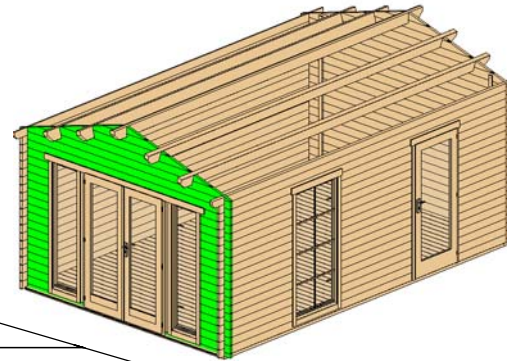



Wall 1			
Mark	Profile	Count	Cut Length

1BL-1	40x57	2	1180
1LG-1	40x114	34	560
1LG-2*	40x114	1	791
1LG-3*	40x114	1	1571
1LG-4*	40x114	1	2351
1LG-5*	40x114	1	3130
1LG-6*	40x114	1	3800
1LG-7	40x114	2	3800

\* Gable - delivered premounted

Log Profile Wall 1	
Profile	Profile

40x57	
40x114	

Columns			
Mark	Profile	Count	Length

CM1	Post 100x40	2	1890
-----	-------------	---	------

# Diana 40 (360x550)

Wall 2

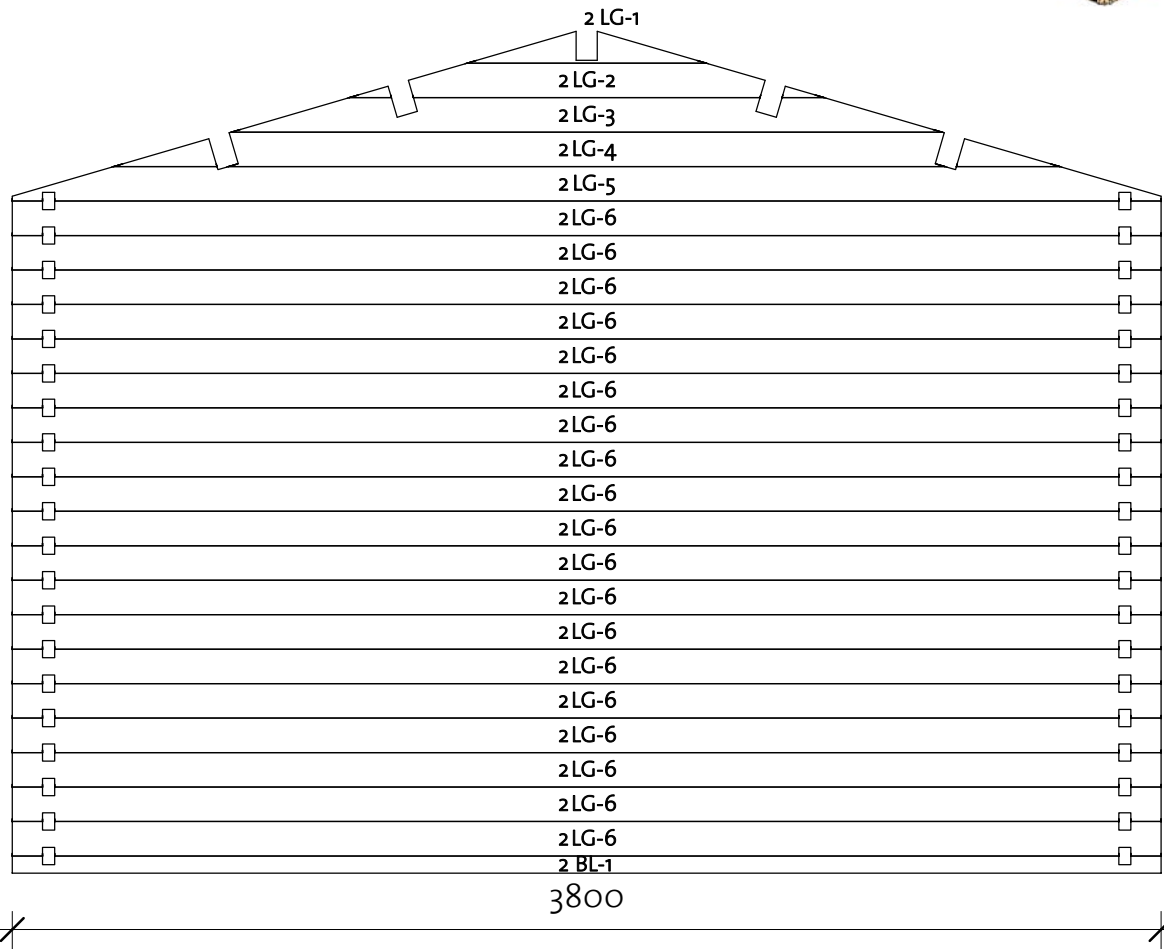
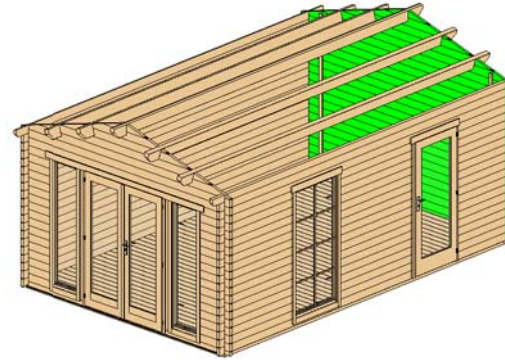

Wall 2			
Mark	Profile	Count	Cut Length

2BL-1	40x57	1	3800
2LG-1*	40x114	1	791
2LG-2*	40x114	1	1571
2LG-3*	40x114	1	2351
2LG-4*	40x114	1	3130
2LG-5*	40x114	1	3800
2LG-6	40x114	19	3800

\* Gable - delivered premounted

Log Profile Wall 2	
Profile	Profile

40x57	
40x114	



# Diana 40 (360x550)

Wall B

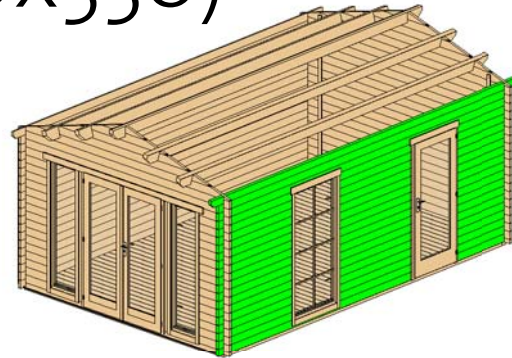

Log Profile Wall B	
Profile	Profile

40X114	
40X114	

Wall B			
Mark	Profile	Count	Cut Length

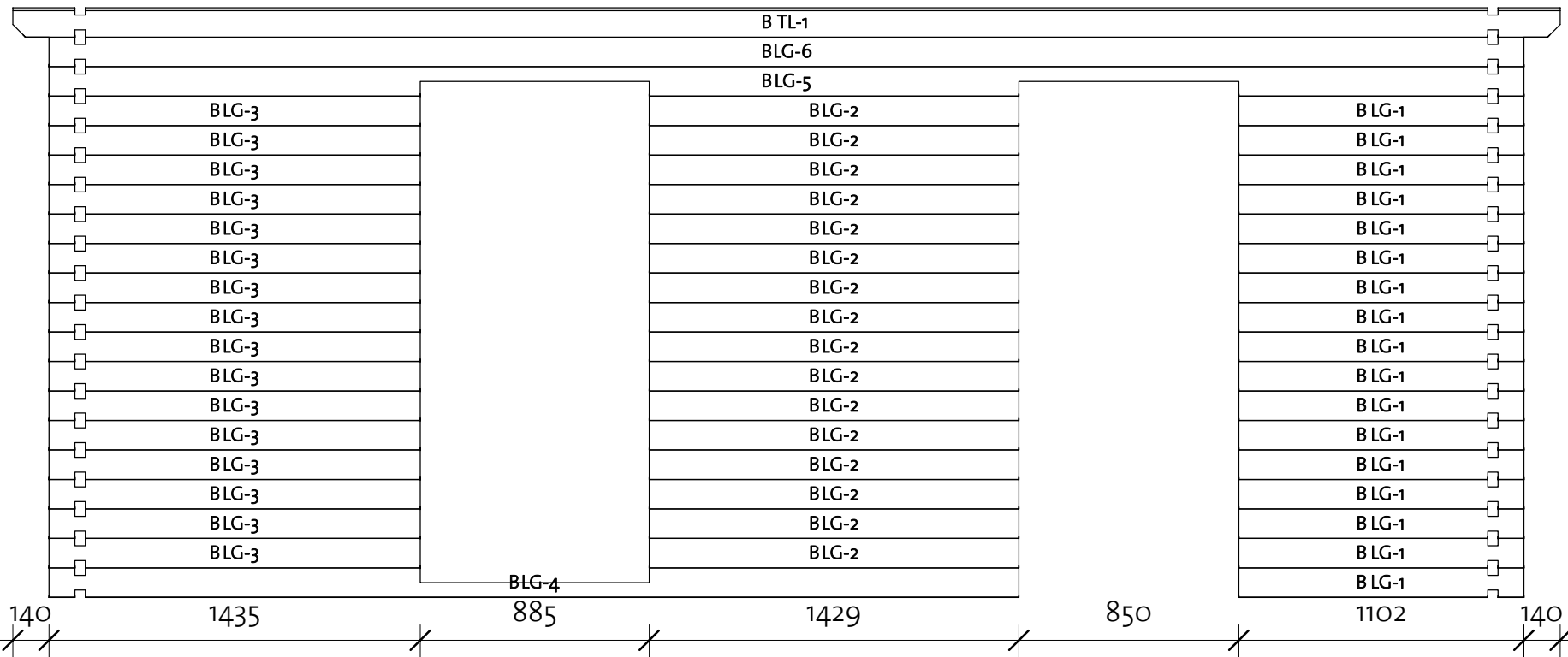

BLG-1	40X114	17	1102
BLG-2	40X114	16	1429
BLG-3	40X114	16	1435
BLG-4	40X114	1	3748
BLG-5	40X114	1	5700
BLG-6	40X114	1	5700
BTL-1	40X114	1	5980

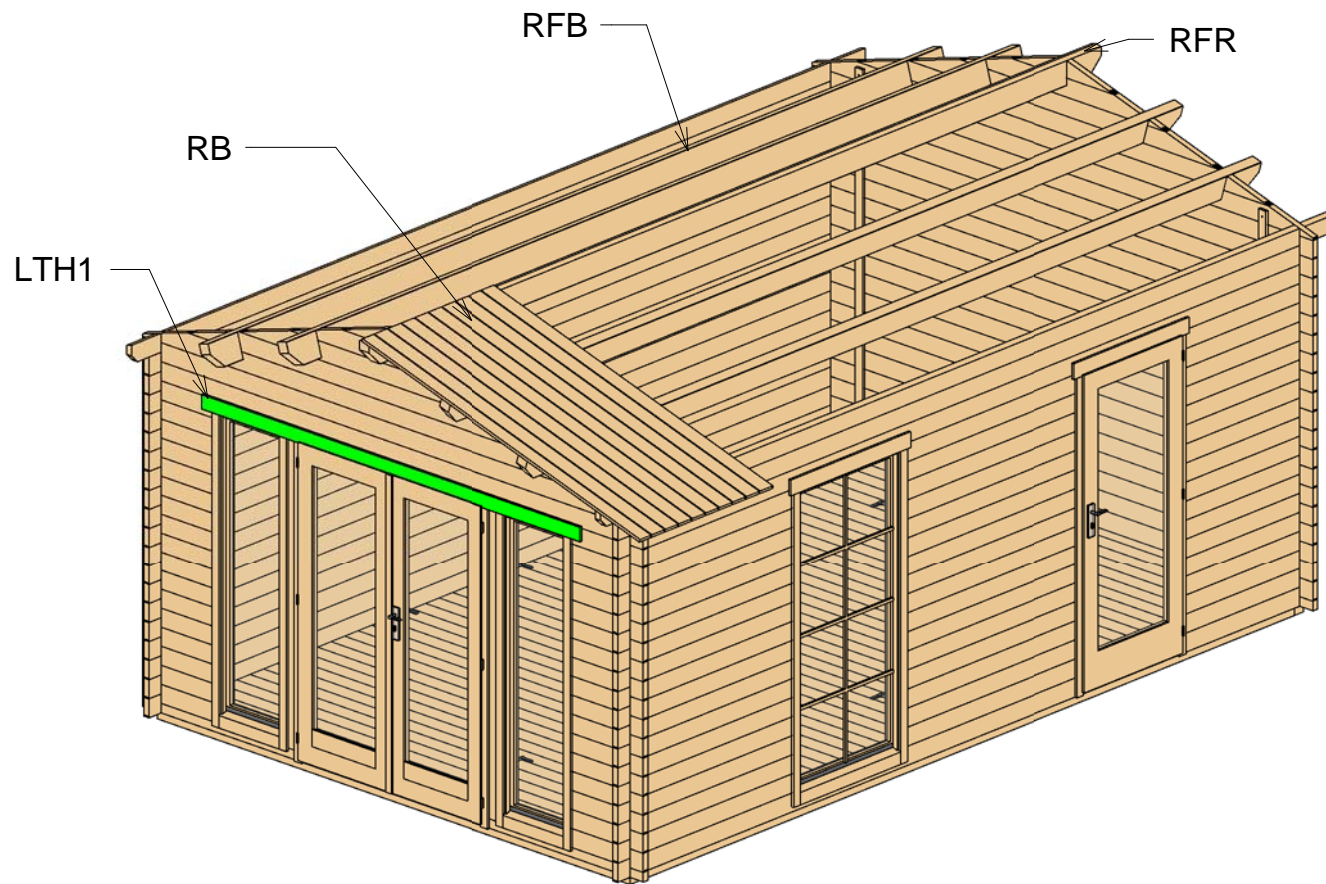

# Diana 40 (360x550)

Roof 1



Roof				
Mark	Type	Profile	Count	Length
RFR	Ridge 70x160		1	5980
RFB	Beam 70x160		4	5980
RB	18x110		112	2200

Lath list				
Mark	Type	Profile	Count	Length
LTH1	18x90		2	2875



# Diana 40 (360x550)

Roof 2

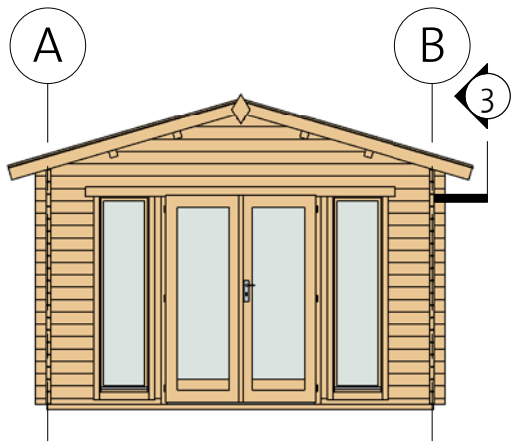
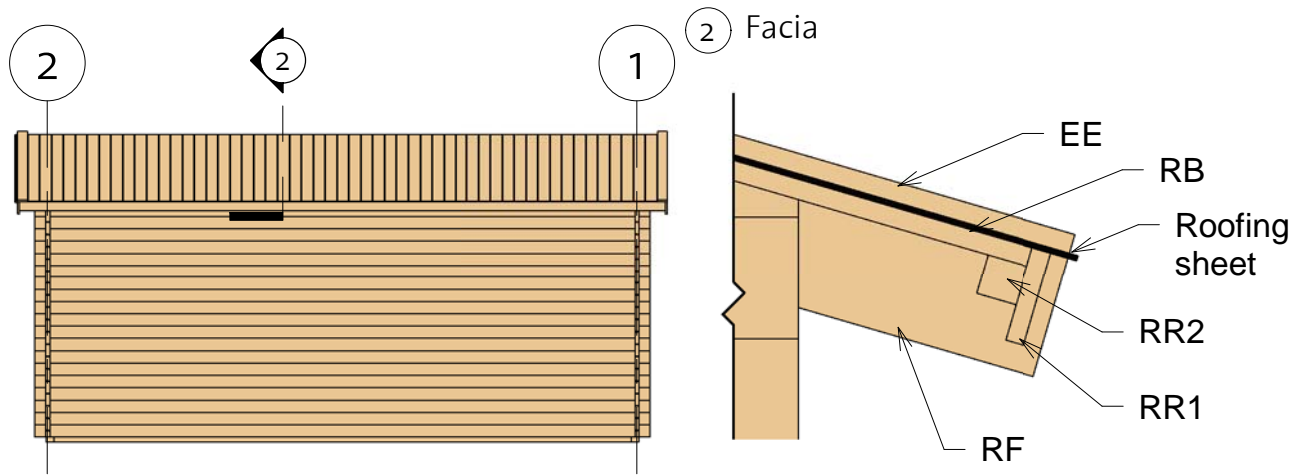

Fascia Schedule				
Mark	Type	Profile	Count	Length

EE	Eave Edging 18x90		4	2240
RF	Roof Fascia 18x115		4	2240
RR1	Roof reinforcement 18x90		2	5980
RR2	Roof reinforcement 38x38		2	5980

# Diana 40 (360x550)

Extras

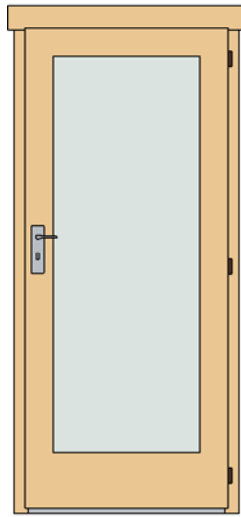
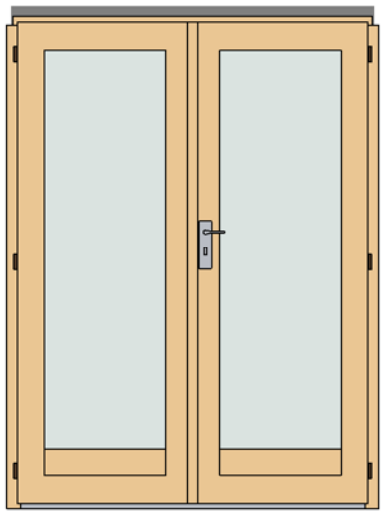

Door Schedule				
Mark	Type	Width	Height	Count

CD6R	Classic door 6, full glass right	840	1955	1
CDD3R	Classic double door 3, full glass right	1425	1955	1



Family	Count
--------	-------

Romb	2
------	---

Type	Count	Length
------	-------	--------

Windboard 18x38	4	2220
-----------------	---	------

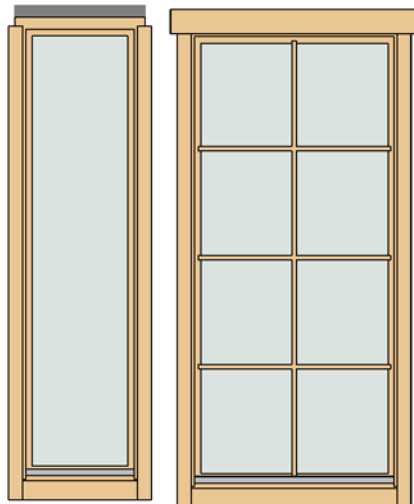

Window Schedule				
Mark	Type	Width	Height	Count

CW3L	Classic window 3, full glass left	515	1890	1
CW3R	Classic window 3, full glass right	515	1890	1
CW4R	Classic window 4 right	875	1890	1
WCB8	Windows Crossbar 8	--	--	1



Fasteners & Extras		
Name	Type	Count

Hitblock	300-400 mm	
Screws	5,0 x 70	10
Bolts	M8 x 70	12
Nails	1,4 x 40	45
Screws	6,0 x 140	60
Screws	4,0 x 40	130
Screws	4,0 x 50	900

# Diana 40 (360x550)

## List of all items 1



### Impregnated foundation beams

Mark	Type	Profile	Count	Length
IFB1	IFB 70x45		8	5350
IFB2	IFB 70x45		2	3590



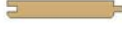

### Floor Schedule

Mark	Type	Profile	Count	Length
FB	FB 18x110		51	3517
BB1	BB 20x40		2	3600
BB2	BB 20x40		2	5500

### Roof

Mark	Type	Profile	Count	Length
RFR	Ridge 70x160		1	5980
RFB	Beam 70x160		4	5980
RB	18x110		112	2200

### Fascia Schedule

Mark	Type	Profile	Count	Length
EE	Eave Edging 18x90		4	2240
RF	Roof Fascia 18x115		4	2240
RR1	Roof reinforcement 18x90		2	5980
RR2	Roof reinforcement 38x38		2	5980

# Diana 40 (360x550)

## List of all items 2

Wall 1			
Mark	Profile	Count	Cut Length

1BL-1	40x57	2	1180
1LG-1	40x114	34	560
1LG-2*	40x114	1	791
1LG-3*	40x114	1	1571
1LG-4*	40x114	1	2351
1LG-5*	40x114	1	3130
1LG-6*	40x114	1	3800
1LG-7	40x114	2	3800



Wall A			
Mark	Profile	Count	Cut Length

ALG-1	40x114	19	5700
ATL-1	40x114	1	5980

Lath list				
Mark	Type	Profile	Count	Length

LTH1	18x90		2	2875
------	-------	---	---	------

Log Profiles	
Profile	Profile

40x57	
40x114	

Wall 2			
Mark	Profile	Count	Cut Length

2BL-1	40x57	1	3800
2LG-1*	40x114	1	791
2LG-2*	40x114	1	1571
2LG-3*	40x114	1	2351
2LG-4*	40x114	1	3130
2LG-5*	40x114	1	3800
2LG-6	40x114	19	3800

\* Gable - delivered premounted

Wall B			
Mark	Profile	Count	Cut Length

BLG-1	40x114	17	1102
BLG-2	40x114	16	1429
BLG-3	40x114	16	1435
BLG-4	40x114	1	3748
BLG-5	40x114	1	5700
BLG-6	40x114	1	5700
BTL-1	40x114	1	5980

Columns			
Mark	Profile	Count	Length

CM1	Post 100x40	2	1890
-----	-------------	---	------

Log Profiles	
Profile	Profile

40x114	
--------	---